

Installationsanleitung 19"-1HE-PC Panel, 24xRJ45 Kat. 6_A
 Installation guide 19"-1U-PC Panel, 24 x RJ45 Cat. 6_A
 Instructions de montage 19"-1U-PC Panel, 24 x RJ45 Cat. 6_A

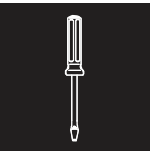

021.3127

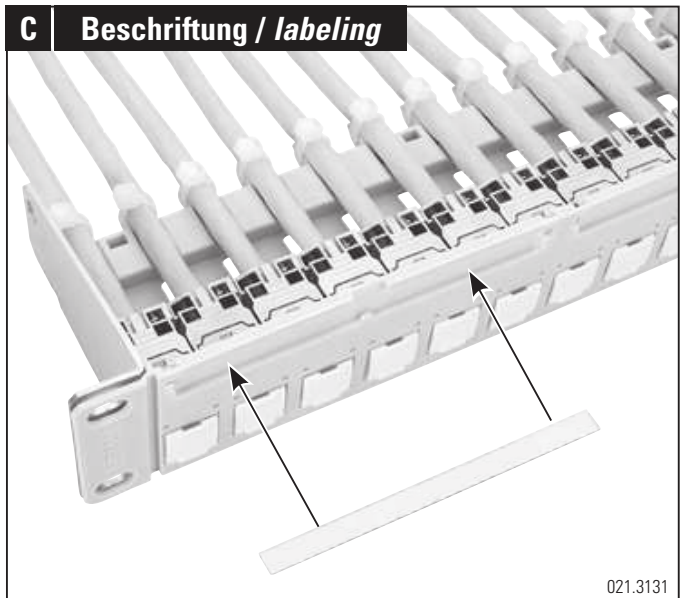
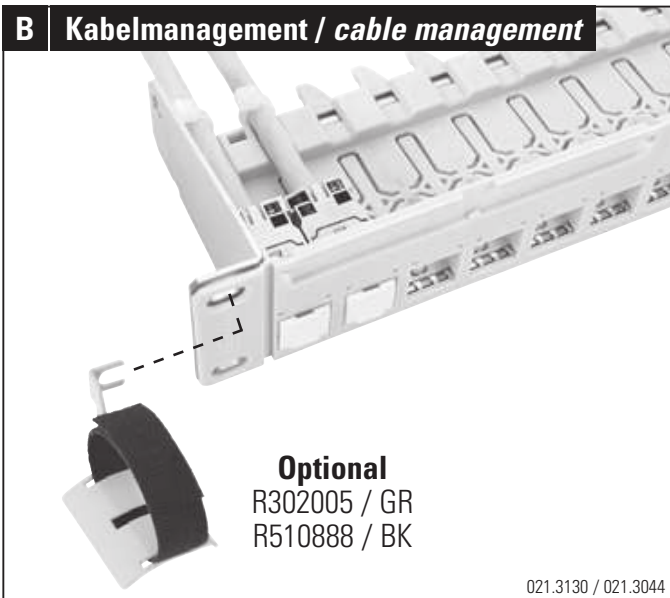
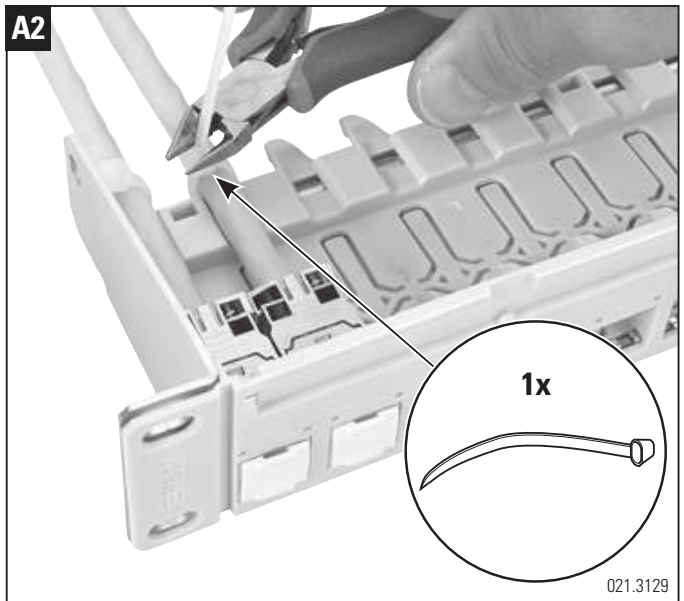
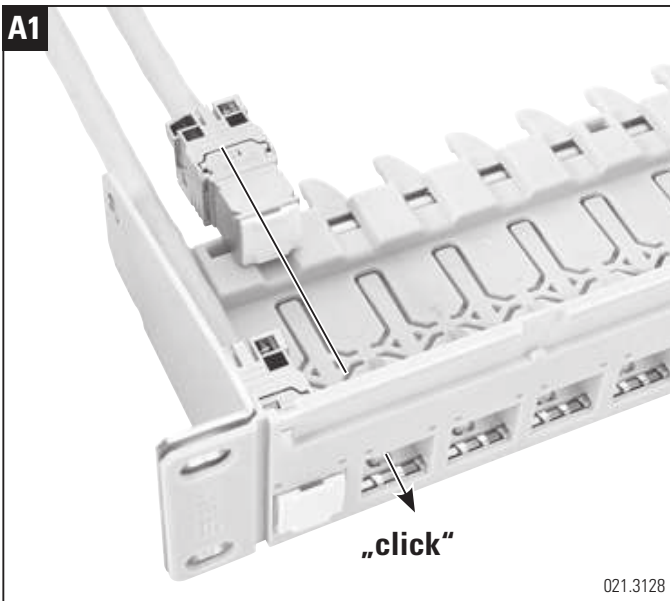

D Farbcodierung und Blindabdeckung /
color coding and dust cover

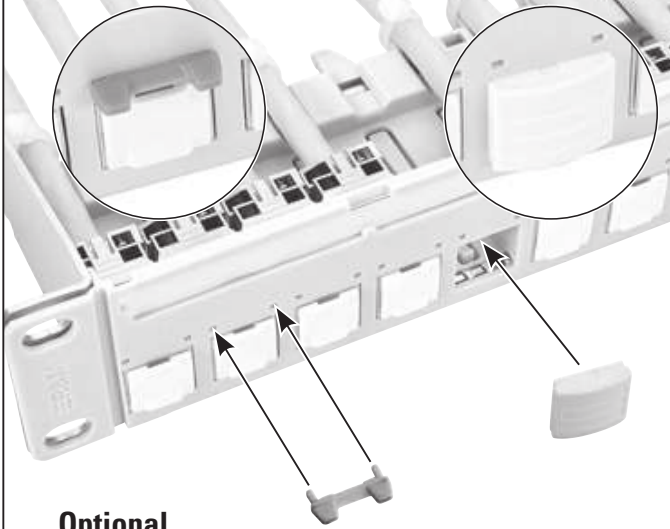

Optional

021.3132 / 021.3133

E Erdung / Grounding



Methode B /
method B

Methode A /
method A

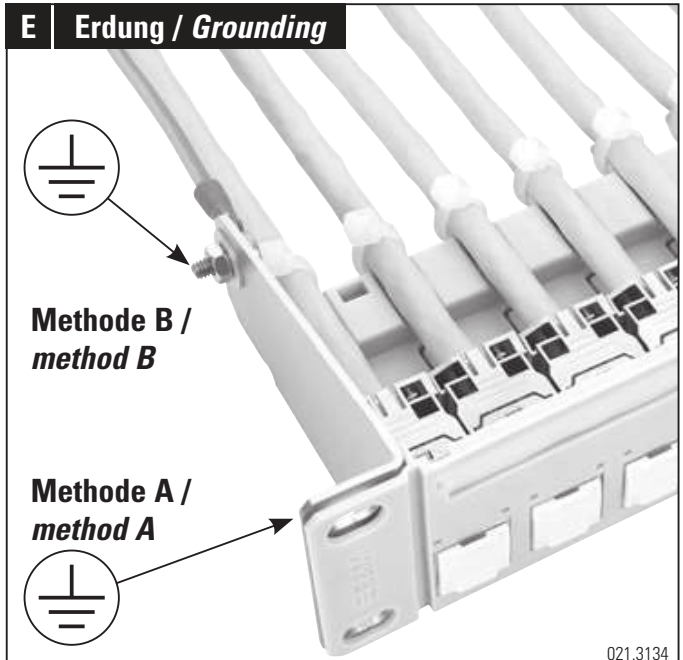

021.3134

F Demontage / Remove

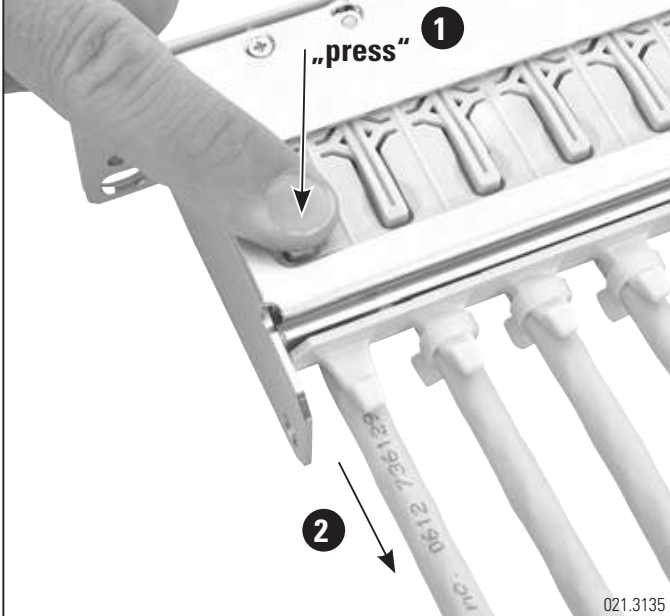

021.3135

G1 R&MinteliPhy

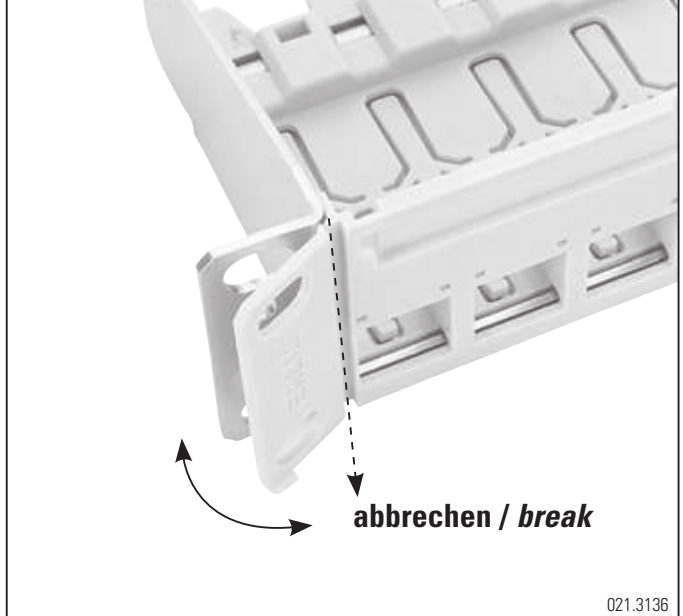

021.3136

G1 R&MinteliPhy



021.3137 / 021.3138

Headquarters

Switzerland

Reichle & De-Massari AG

Binzstrasse 32

CHE-8620 Wetzikon

Telephone HQ +41 (0)44 933 81 11

Telefax HQ +41 (0)44 930 49 41

E-Mail info@rdm.ch

www.rdm.com

